Socio-technical Systems

Objectives

- To explain what a socio-technical system is and the distinction between this and a computer-based system
- To introduce the concept of emergent system properties such as reliability and security
- To explain system engineering and system procurement processes
- To explain why the organisational context of a system affects its design and use
- To discuss legacy systems and why these are critical to many businesses

Topics covered

- Emergent system properties
- Systems engineering
- Organizations, people and computer systems
- Legacy systems

What is a system?

- A purposeful collection of inter-related components working together to achieve some common objective.
- A system may include software, mechanical, electrical and electronic hardware and be operated by people.
- System components are dependent on other system components
- The properties and behaviour of system components are inextricably inter-mingled

System categories

- Technical computer-based systems
 - Systems that include hardware and software but where the operators and operational processes are not normally considered to be part of the system. The system is not self-aware.
- Socio-technical systems
 - Systems that include technical systems but also operational processes and people who use and interact with the technical system. Socio-technical systems are governed by organisational policies and rules.

Socio-technical system characteristics

- Emergent properties
 - Properties of the system of a whole that depend on the system components and their relationships.
- Non-deterministic
 - They do not always produce the same output when presented with the same input because the systems's behaviour is partially dependent on human operators.
- Complex relationships with organisational objectives
 - The extent to which the system supports organisational objectives does not just depend on the system itself.

Emergent properties

- Properties of the system as a whole rather than properties that can be derived from the properties of components of a system
- Emergent properties are a consequence of the relationships between system components
- They can therefore only be assessed and measured once the components have been integrated into a system

Examples of emergent properties

Property	Description
Volume	The volume of a system (the total space occupied) varies depending on how the component assemblies are arranged and connected.
Reliability	System reliability depends on component reliability but unexpected interactions can cause new types of failure and therefore affect the reliability of the system.
Security	The security of the system (its ability to resist attack) is a complex property that cannot be easily measured. Attacks may be devised that were not anticipated by the system designers and so may defeat built-in safeguards.
Repairability	This property reflects how easy it is to fix a problem with the system once it has been discovered. It depends on being able to diagnose the problem, access the components that are faulty and modify or replace these components.
Usability	This property reflects how easy it is to use the system. It depends on the technical system components, its operators and its operating environment.

Types of emergent property

- Functional properties
 - These appear when all the parts of a system work together to achieve some objective. For example, a bicycle has the functional property of being a transportation device once it has been assembled from its components.
- Non-functional emergent properties
 - Examples are reliability, performance, safety, and security. These relate to the behaviour of the system in its operational environment. They are often critical for computer-based systems as failure to achieve some minimal defined level in these properties may make the system unusable.

System reliability engineering

- Because of component inter-dependencies, faults can be propagated through the system.
- System failures often occur because of unforeseen inter-relationships between components.
- It is probably impossible to anticipate all possible component relationships.
- Software reliability measures may give a false picture of the system reliability.

Influences on reliability

- *Hardware reliability*
 - What is the probability of a hardware component failing and how long does it take to repair that component?
- *Software reliability*
 - How likely is it that a software component will produce an incorrect output. Software failure is usually distinct from hardware failure in that software does not wear out.
- *Operator reliability*
 - How likely is it that the operator of a system will make an error?

Reliability relationships

- Hardware failure can generate spurious signals that are outside the range of inputs expected by the software.
- Software errors can cause alarms to be activated which cause operator stress and lead to operator errors.
- The environment in which a system is installed can affect its reliability.

The 'shall-not' properties

- Properties such as performance and reliability can be measured.
- However, some properties are properties that the system should not exhibit
 - Safety - the system should not behave in an unsafe way;
 - Security - the system should not permit unauthorised use.
- Measuring or assessing these properties is very hard.

Systems engineering

- Specifying, designing, implementing, validating, deploying and maintaining socio-technical systems.
- Concerned with the services provided by the system, constraints on its construction and operation and the ways in which it is used.

The system engineering process

- Usually follows a ‘waterfall’ model because of the need for parallel development of different parts of the system
 - Little scope for iteration between phases because hardware changes are very expensive. Software may have to compensate for hardware problems.
- Inevitably involves engineers from different disciplines who must work together
 - Much scope for misunderstanding here. Different disciplines use a different vocabulary and much negotiation is required. Engineers may have personal agendas to fulfil.

The systems engineering process

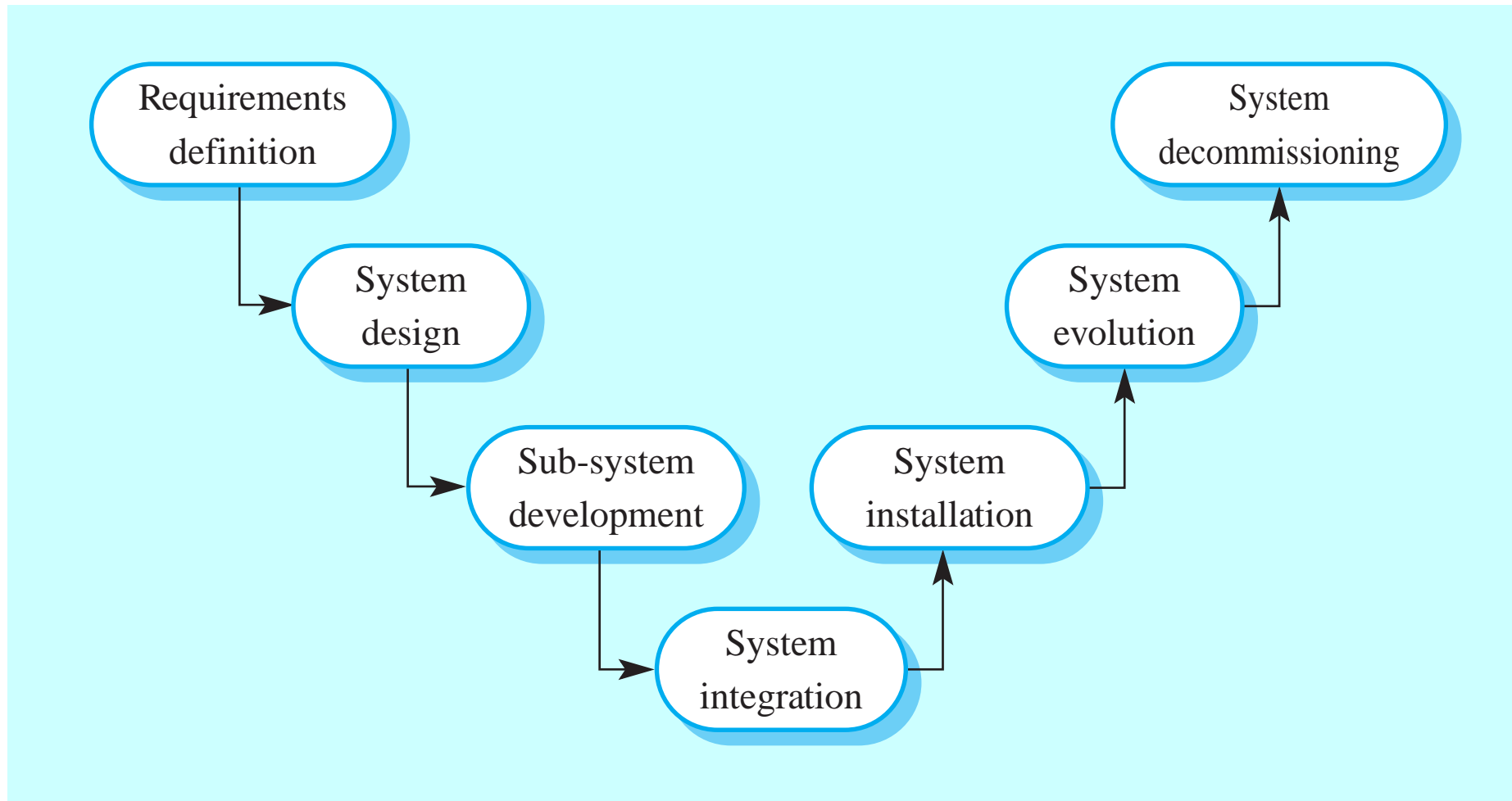

Inter-disciplinary involvement

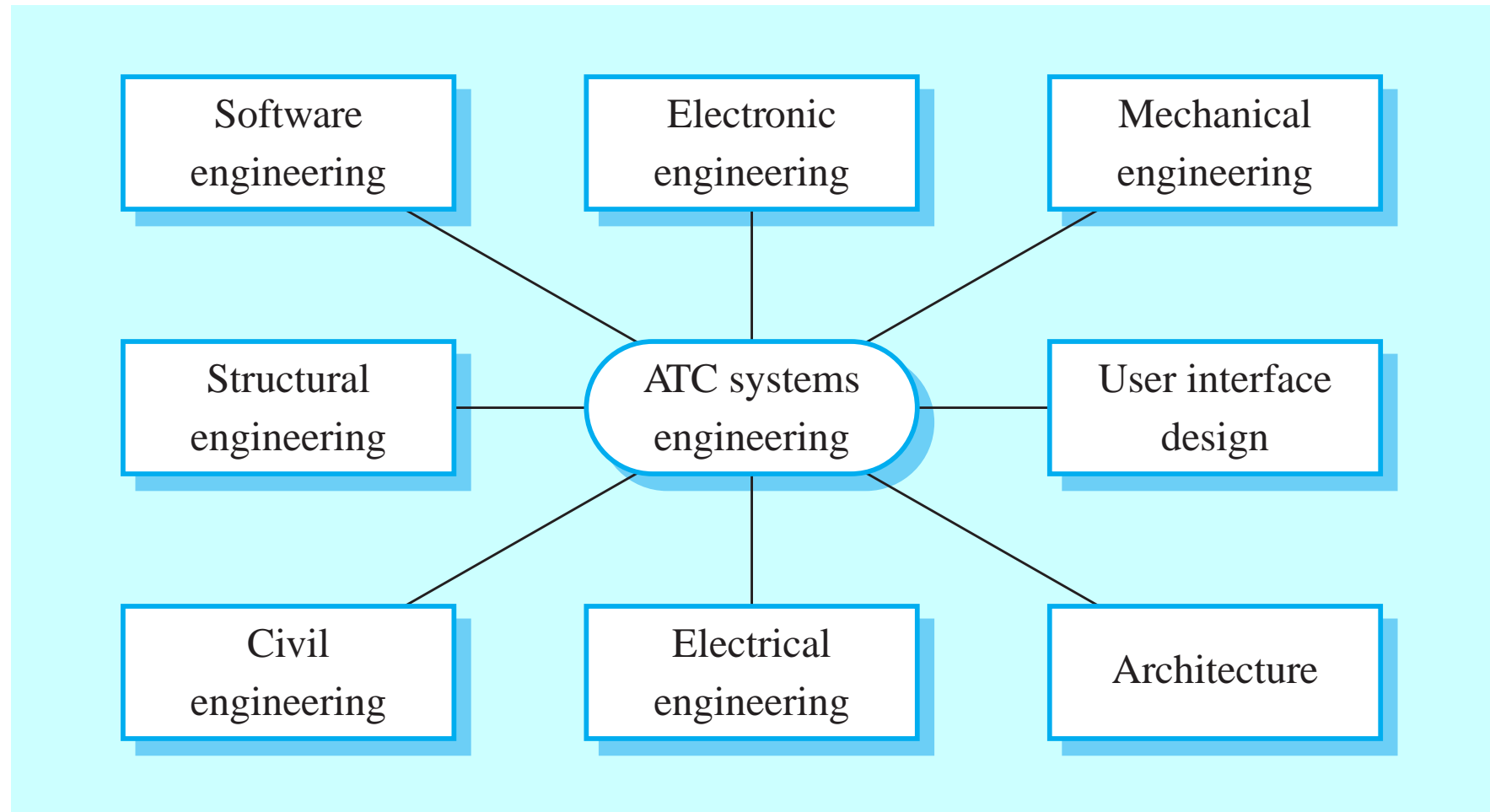

System requirements definition

- Three types of requirement defined at this stage
 - Abstract functional requirements. System functions are defined in an abstract way;
 - System properties. Non-functional requirements for the system in general are defined;
 - Undesirable characteristics. Unacceptable system behaviour is specified.
- Should also define overall organisational objectives for the system.

System objectives

- Should define why a system is being procured for a particular environment.
- Functional objectives
 - To provide a fire and intruder alarm system for the building which will provide internal and external warning of fire or unauthorized intrusion.
- Organisational objectives
 - To ensure that the normal functioning of work carried out in the building is not seriously disrupted by events such as fire and unauthorized intrusion.

System requirements problems

- Complex systems are usually developed to address wicked problems
 - Problems that are not fully understood;
 - Changing as the system is being specified.
- Must anticipate hardware/communications developments over the lifetime of the system.
- Hard to define non-functional requirements (particularly) without knowing the component structure of the system.

The system design process

- Partition requirements
 - Organise requirements into related groups.
- Identify sub-systems
 - Identify a set of sub-systems which collectively can meet the system requirements.
- Assign requirements to sub-systems
 - Causes particular problems when COTS are integrated.
- Specify sub-system functionality.
- Define sub-system interfaces
 - Critical activity for parallel sub-system development.

The system design process

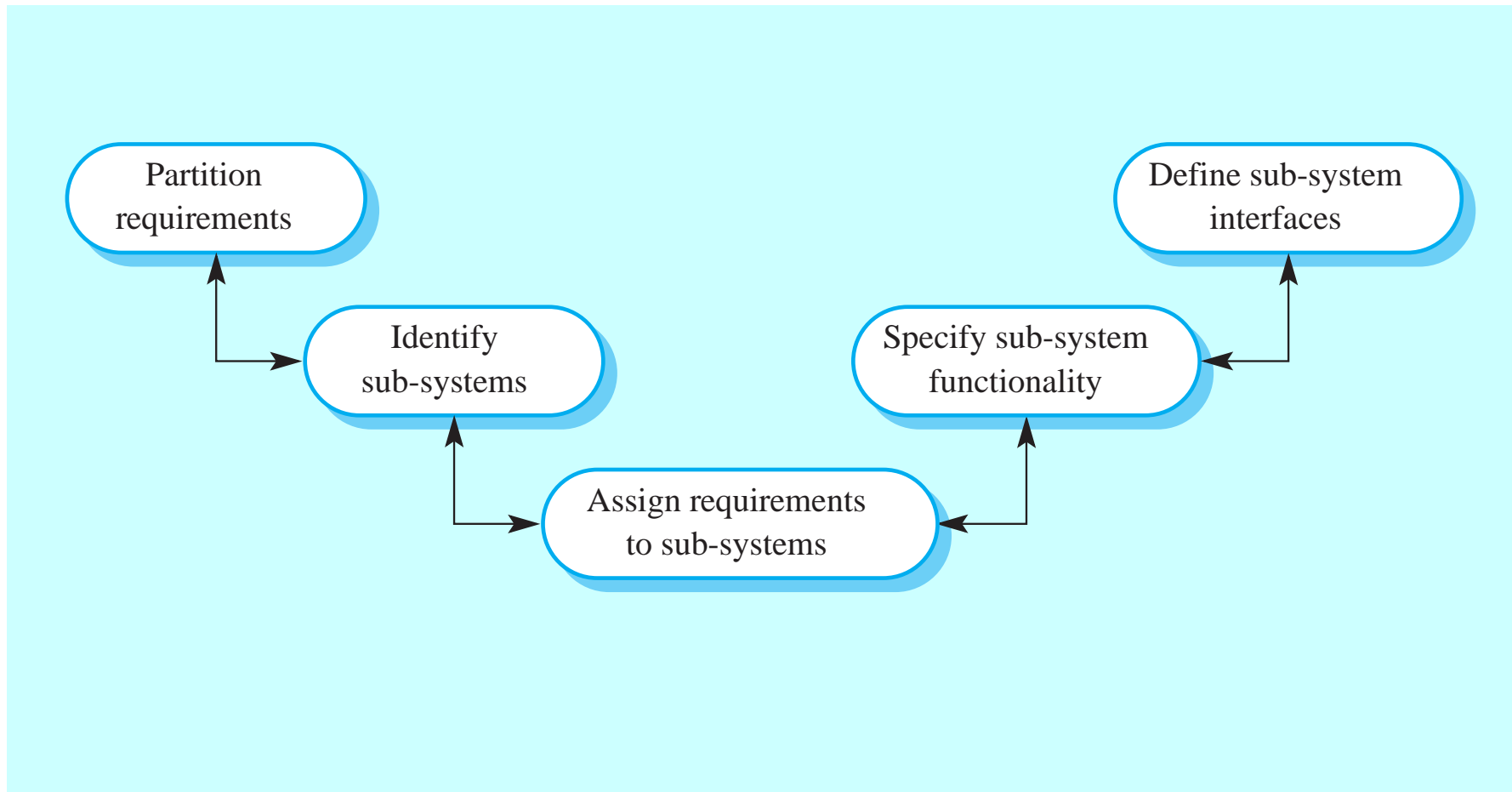

System design problems

- Requirements partitioning to hardware, software and human components may involve a lot of negotiation.
- Difficult design problems are often assumed to be readily solved using software.
- Hardware platforms may be inappropriate for software requirements so software must compensate for this.

Requirements and design

- Requirements engineering and system design are inextricably linked.
- Constraints posed by the system's environment and other systems limit design choices so the actual design to be used may be a requirement.
- Initial design may be necessary to structure the requirements.
- As you do design, you learn more about the requirements.

Spiral model of requirements/design

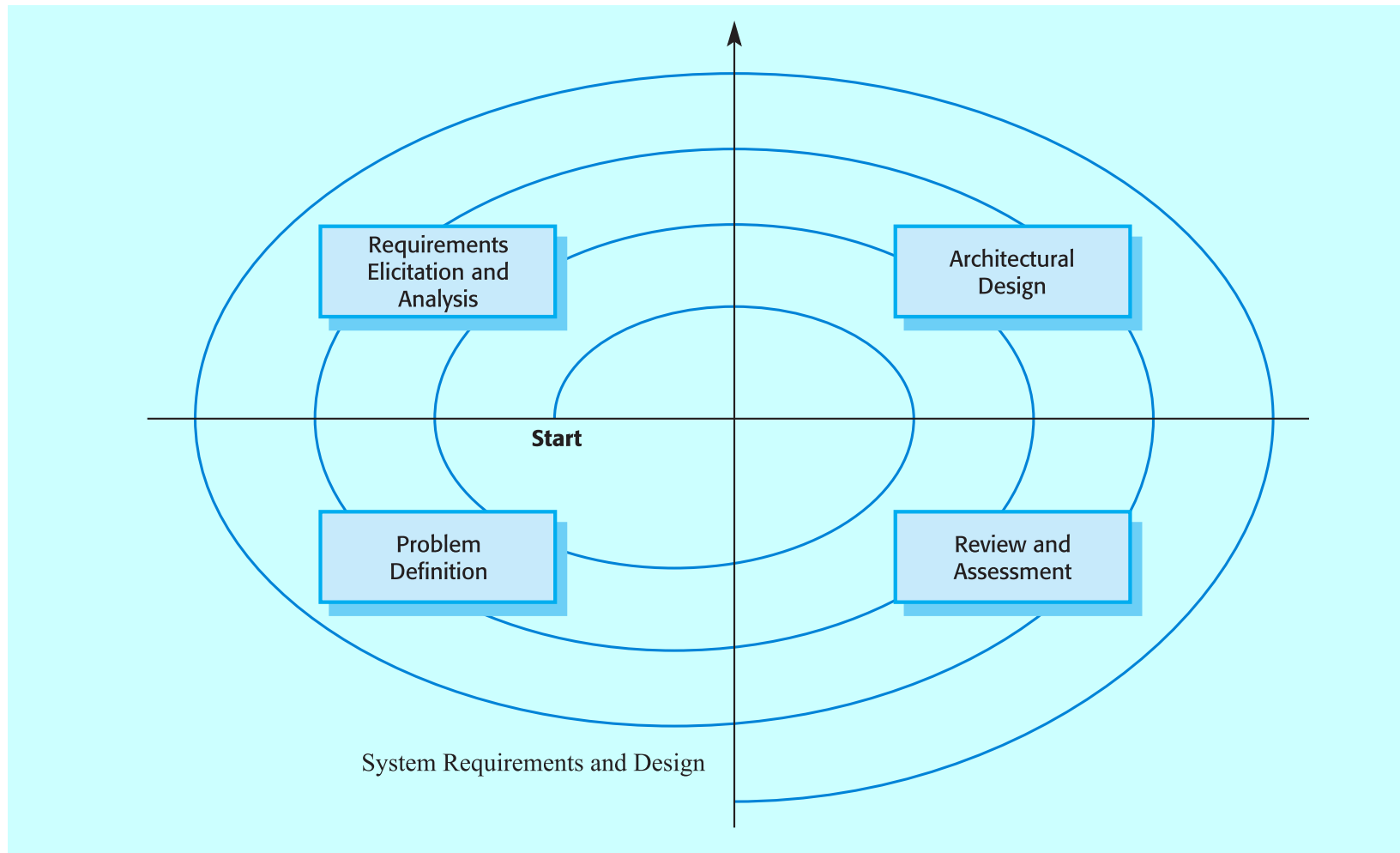

System modelling

- An architectural model presents an abstract view of the sub-systems making up a system
- May include major information flows between sub-systems
- Usually presented as a block diagram
- May identify different types of functional component in the model

Burglar alarm system

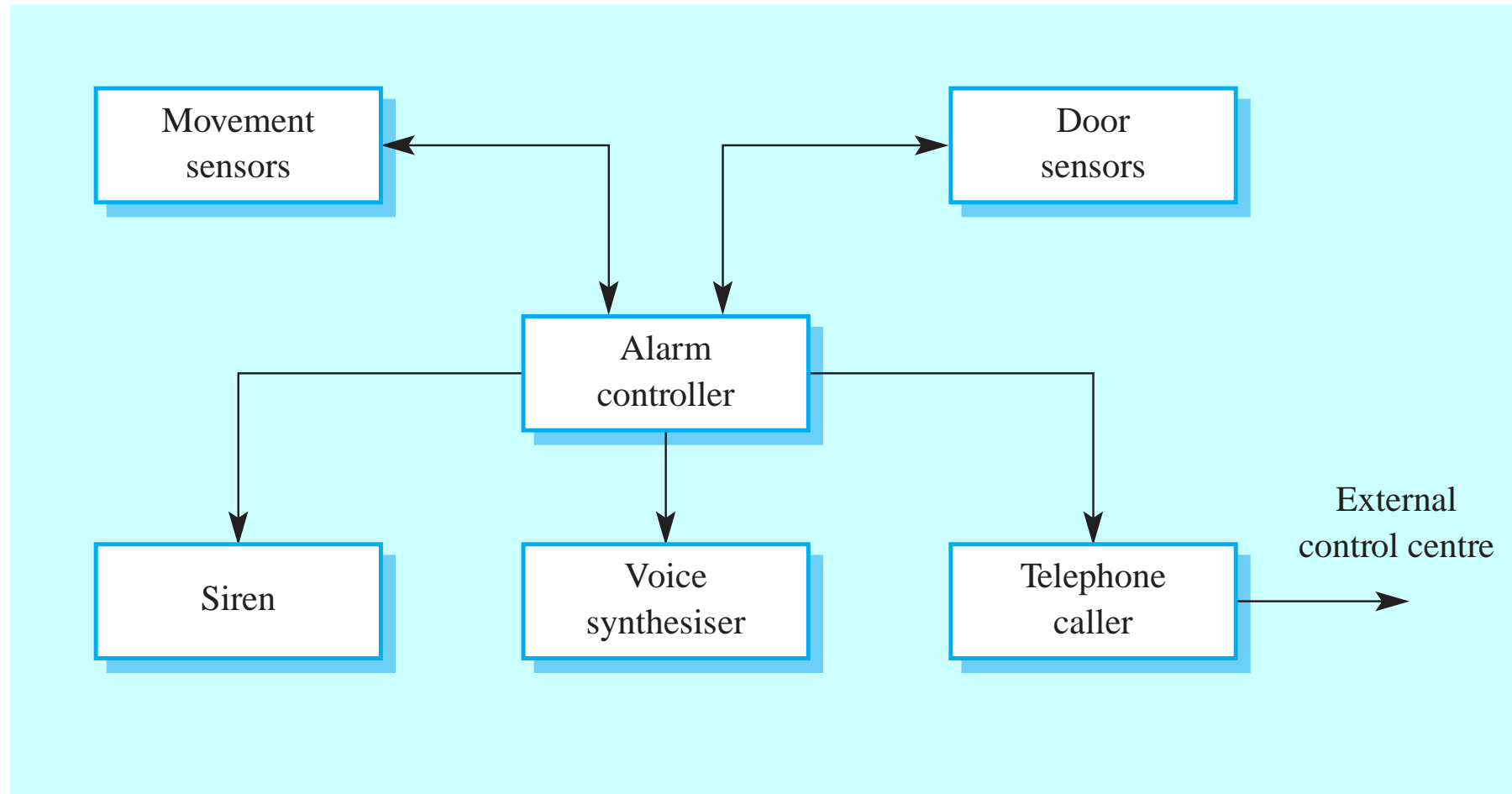

Sub-system description

Sub-system	Description
Movement sensors	Detects movement in the rooms monitored by the system
Door sensors	Detects door opening in the external doors of the building
Alarm controller	Controls the operation of the system
Siren	Emits an audible warning when an intruder is suspected
Voice synthesizer	Synthesizes a voice message giving the location of the suspected intruder
Telephone caller	Makes external calls to notify security, the police, etc.

ATC system architecture

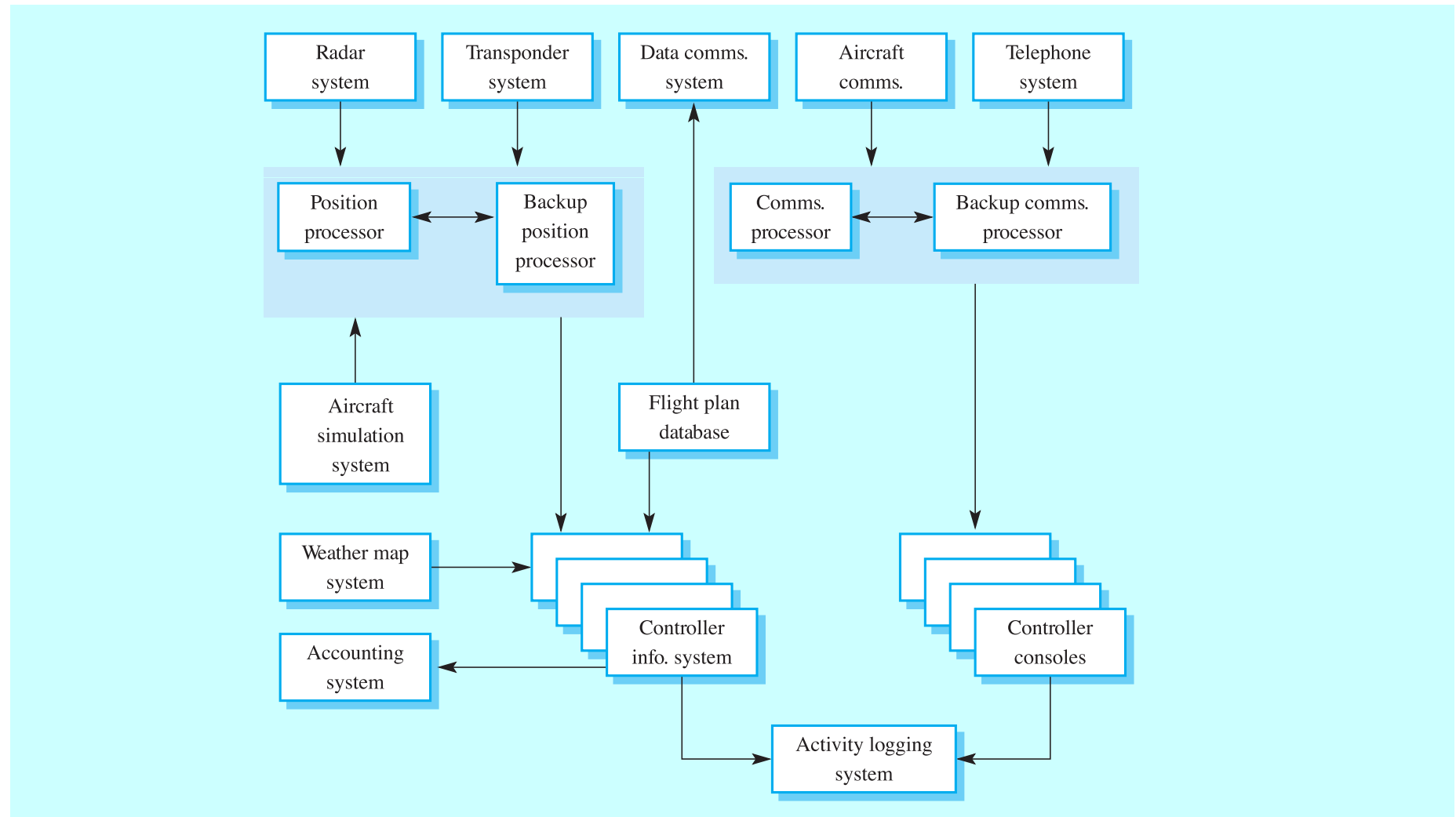

Sub-system development

- Typically parallel projects developing the hardware, software and communications.
- May involve some COTS (Commercial Off-the-Shelf) systems procurement.
- Lack of communication across implementation teams.
- Bureaucratic and slow mechanism for proposing system changes means that the development schedule may be extended because of the need for rework.

System integration

- The process of putting hardware, software and people together to make a system.
- Should be tackled incrementally so that sub-systems are integrated one at a time.
- Interface problems between sub-systems are usually found at this stage.
- May be problems with uncoordinated deliveries of system components.

System installation

- After completion, the system has to be installed in the customer's environment
 - Environmental assumptions may be incorrect;
 - May be human resistance to the introduction of a new system;
 - System may have to coexist with alternative systems for some time;
 - May be physical installation problems (e.g. cabling problems);
 - Operator training has to be identified.

System evolution

- Large systems have a long lifetime. They must evolve to meet changing requirements.
- Evolution is inherently costly
 - Changes must be analysed from a technical and business perspective;
 - Sub-systems interact so unanticipated problems can arise;
 - There is rarely a rationale for original design decisions;
 - System structure is corrupted as changes are made to it.
- Existing systems which must be maintained are sometimes called **legacy systems**.

System decommissioning

- Taking the system out of service after its useful lifetime.
- May require removal of materials (e.g. dangerous chemicals) which pollute the environment
 - Should be planned for in the system design by encapsulation.
- May require data to be restructured and converted to be used in some other system.

Organisations/people/systems

- Socio-technical systems are organisational systems intended to help deliver some organisational or business goal.
- If you do not understand the organisational environment where a system is used, the system is less likely to meet the real needs of the business and its users.

Human and organisational factors

- *Process changes*
 - Does the system require changes to the work processes in the environment?
- *Job changes*
 - Does the system de-skill the users in an environment or cause them to change the way they work?
- *Organisational changes*
 - Does the system change the political power structure in an organisation?

Organisational processes

- The processes of systems engineering overlap and interact with organisational procurement processes.
- Operational processes are the processes involved in using the system for its intended purpose. For new systems, these have to be defined as part of the system design.
- Operational processes should be designed to be flexible and should not force operations to be done in a particular way. It is important that human operators can use their initiative if problems arise.

Procurement/development processes

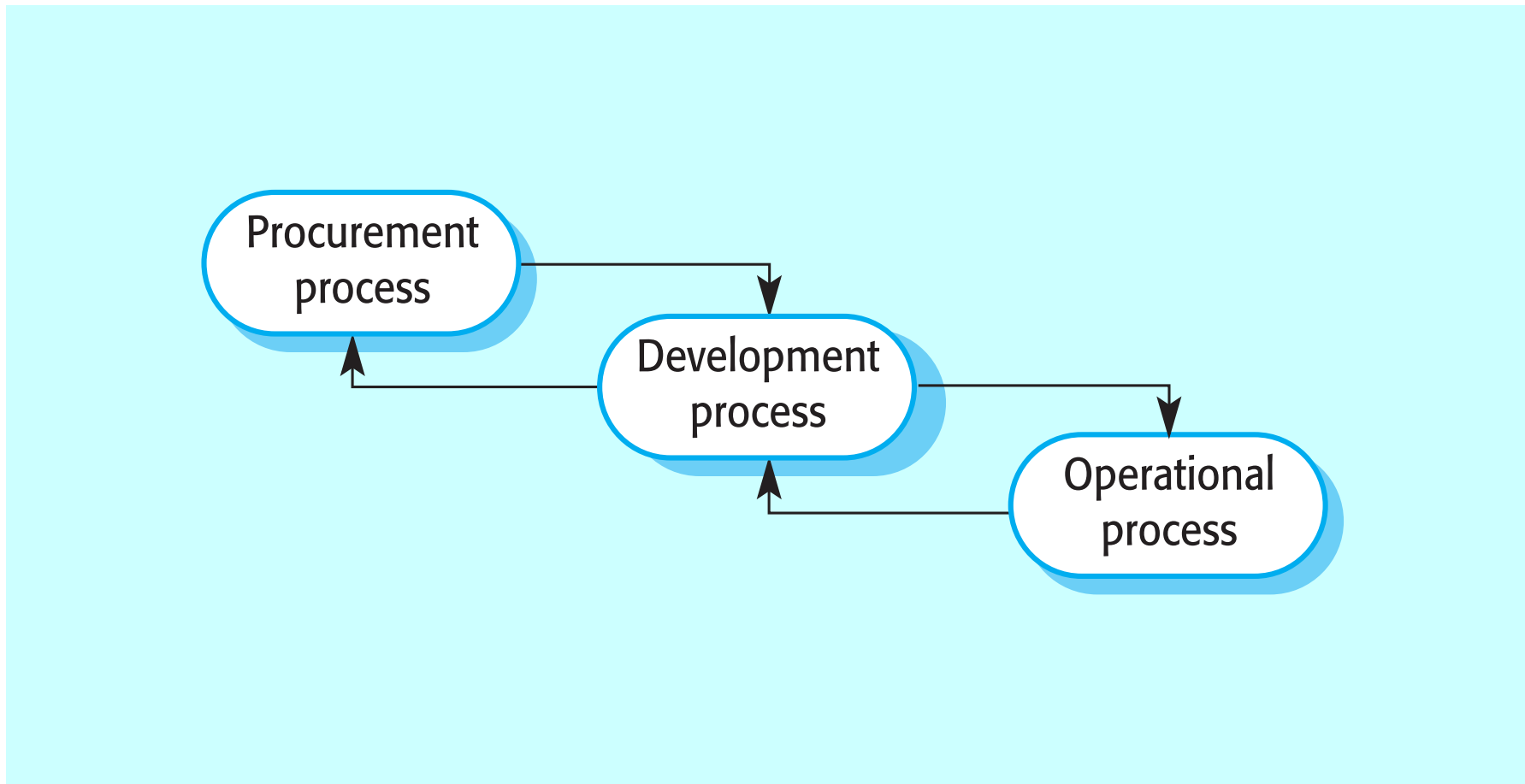

System procurement

- Acquiring a system for an organization to meet some need
- Some system specification and architectural design is usually necessary before procurement
 - You need a specification to let a contract for system development
 - The specification may allow you to buy a commercial off-the-shelf (COTS) system. Almost always cheaper than developing a system from scratch
- Large complex systems usually consist of a mix of off the shelf and specially designed components. The procurement processes for these different types of component are usually different.

The system procurement process

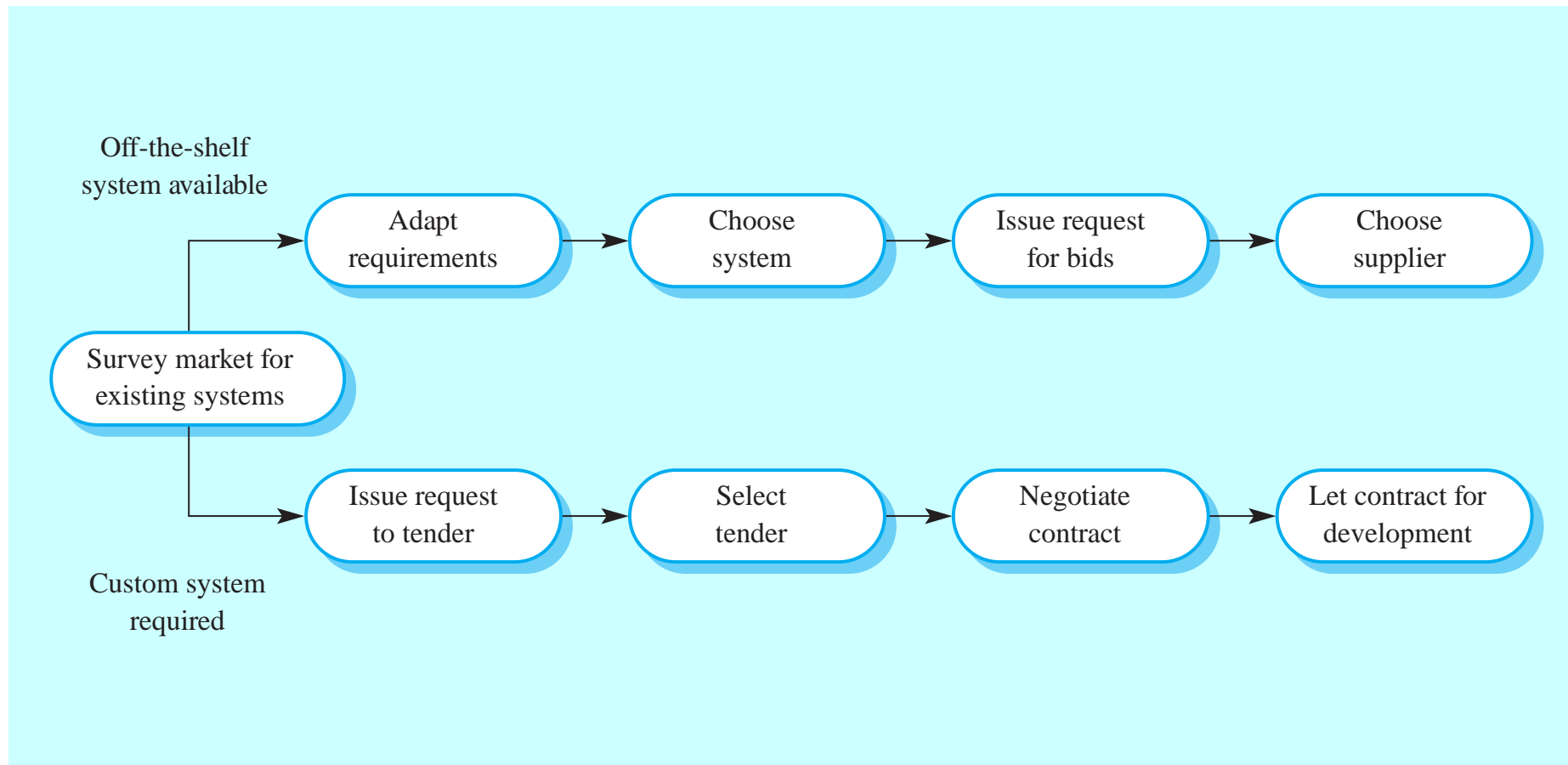

Procurement issues

- Requirements may have to be modified to match the capabilities of off-the-shelf components.
- The requirements specification may be part of the contract for the development of the system.
- There is usually a contract negotiation period to agree changes after the contractor to build a system has been selected.

Contractors and sub-contractors

- The procurement of large hardware/software systems is usually based around some principal contractor.
- Sub-contracts are issued to other suppliers to supply parts of the system.
- Customer liases with the principal contractor and does not deal directly with sub-contractors.

Contractor/Sub-contractor model

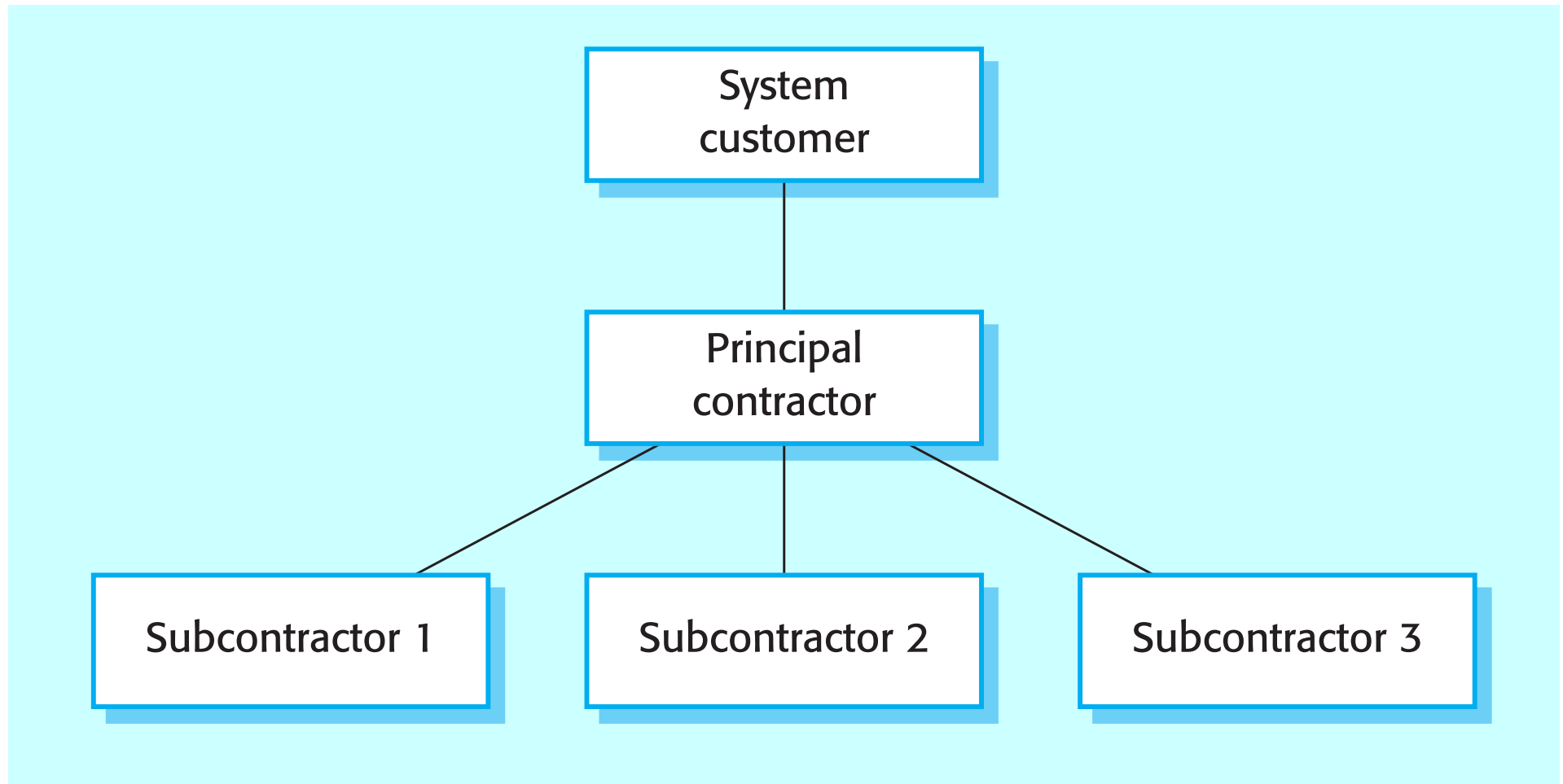

Legacy systems

- Socio-technical systems that have been developed using old or obsolete technology.
- Crucial to the operation of a business and it is often too risky to discard these systems
 - Bank customer accounting system;
 - Aircraft maintenance system.
- Legacy systems constrain new business processes and consume a high proportion of company budgets.

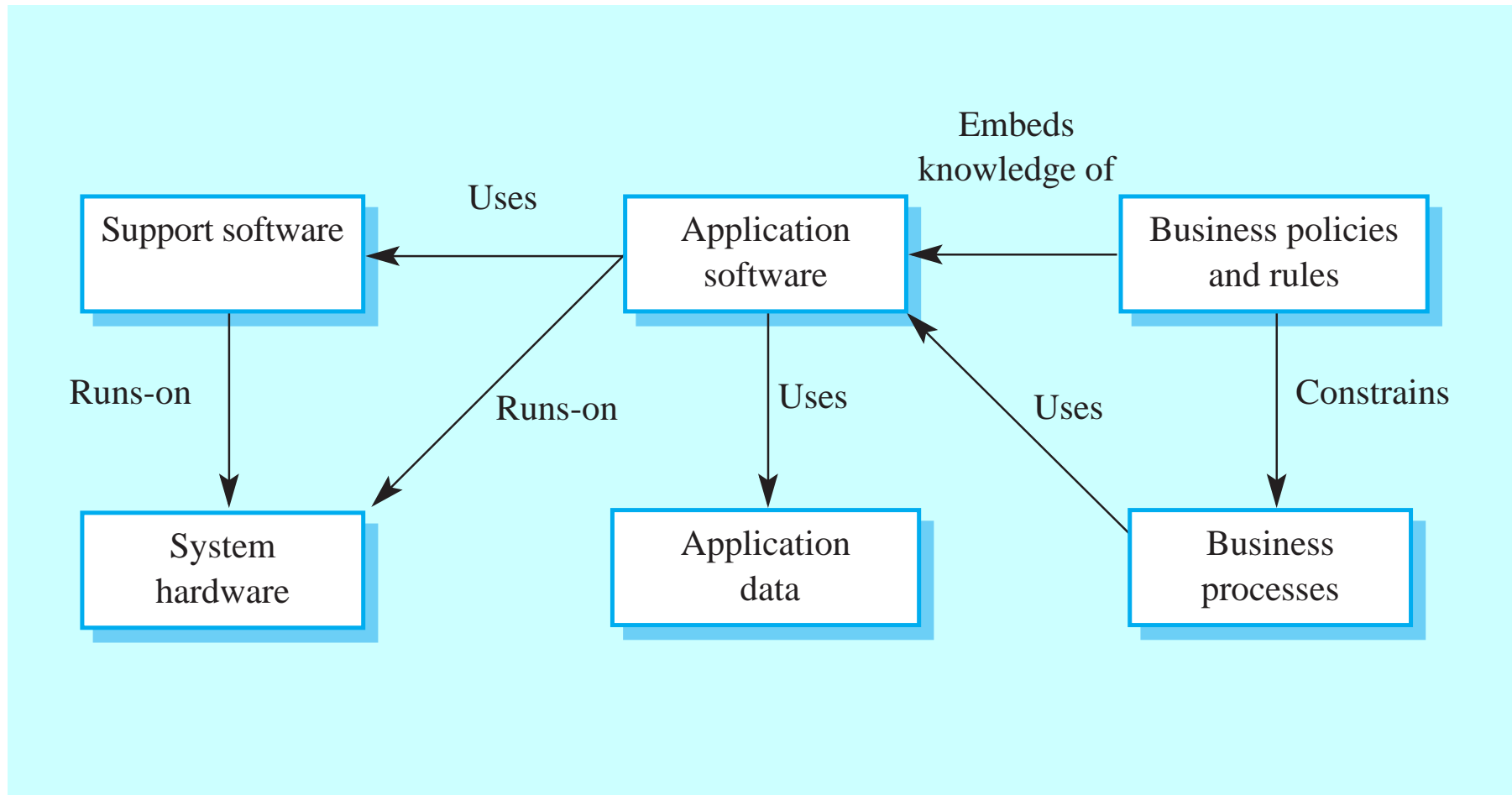

Legacy system components

- Hardware - may be obsolete mainframe hardware.
- Support software - may rely on support software from suppliers who are no longer in business.
- Application software - may be written in obsolete programming languages.
- Application data - often incomplete and inconsistent.
- Business processes - may be constrained by software structure and functionality.
- Business policies and rules - may be implicit and embedded in the system software.

Socio-technical system

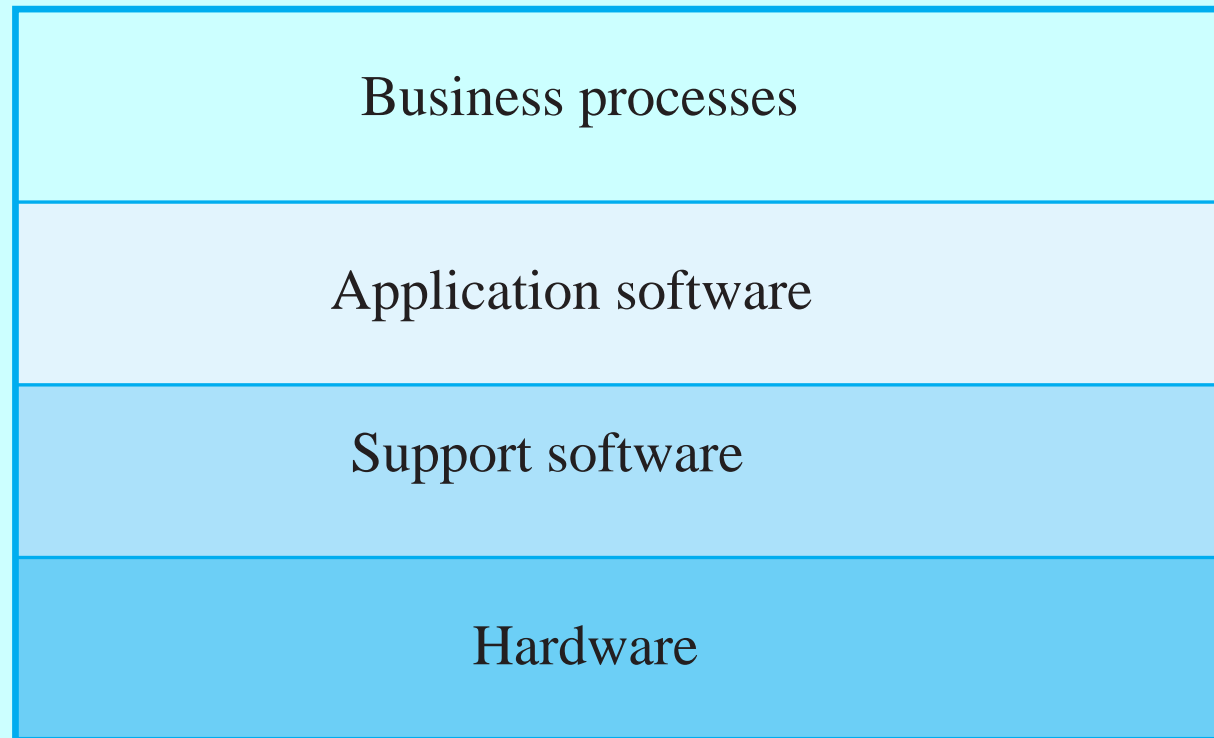

Key points

- Socio-technical systems include computer hardware, software and people and are designed to meet some business goal.
- Emergent properties are properties that are characteristic of the system as a whole and not its component parts.
- The systems engineering process includes specification, design, development, integration and testing. System integration is particularly critical.

Key points

- Human and organisational factors have a significant effect on the operation of socio-technical systems.
- There are complex interactions between the processes of system procurement, development and operation.
- A legacy system is an old system that continues to provide essential services.
- Legacy systems include business processes, application software, support software and system hardware.